

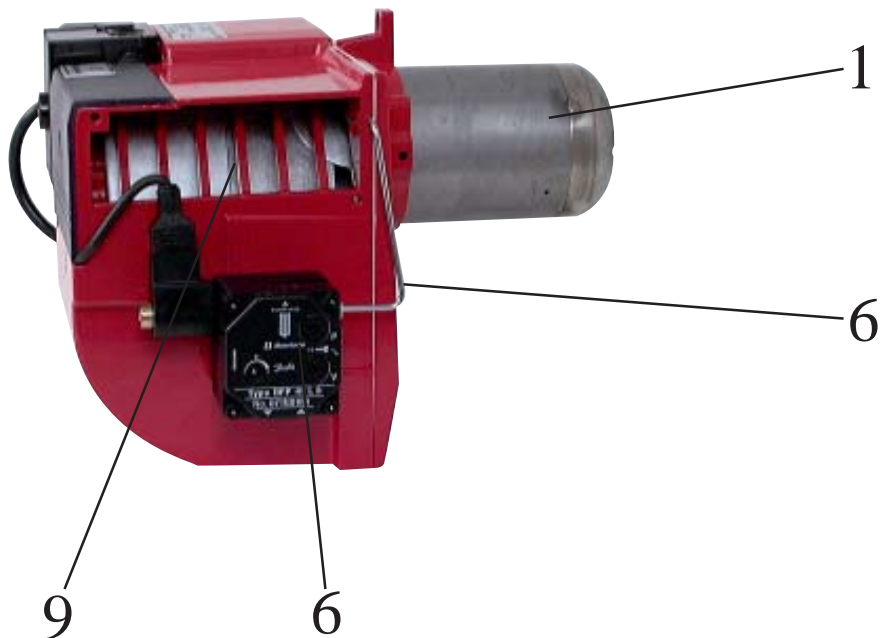

97,108, 120

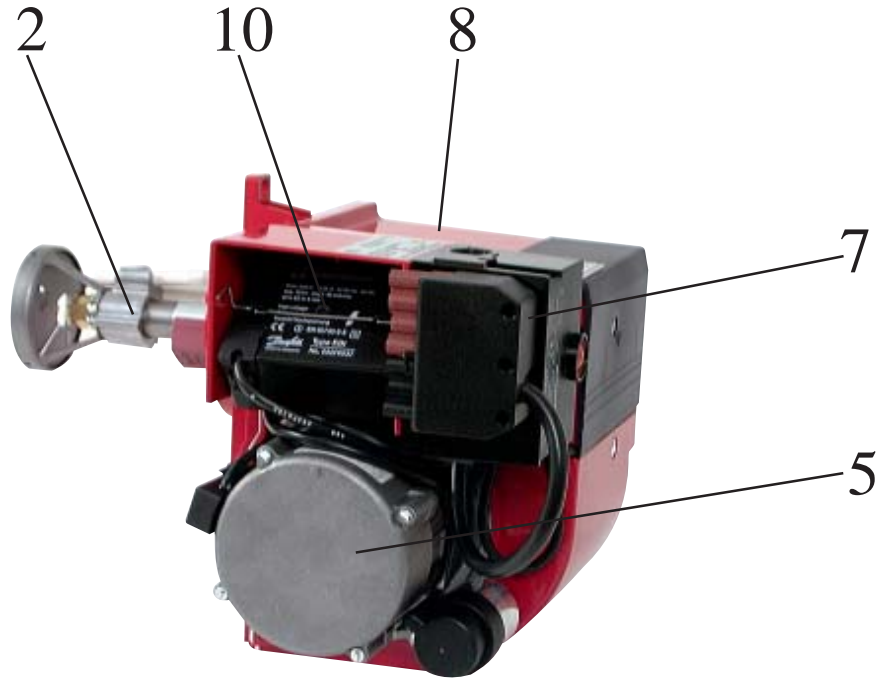







INNEHÅLLSFÖRTECKNING

INHALTSVERZEICHNIS

TABLE OF CONTENTS

TABLE DES MATIERES

1. BRÄNNARRÖR BRENNERROHR	BURNER TUBE TUBE DIFFUSEUR
2. INSATS DÜSENSTOCK	NOZZLE ASSEMBLY LIGNE PORTE-GICLEUR
3. ANSLUTNINGSFLÄNS BEFESTIGUNGSFLANSCH	FIXING FLANGE BRIDE DE FIXATION
4. KÅPA ABDECKHAUBE	COVER CAPOT
5. MOTOR MOTOR	MOTOR MOTEUR
6. PUMP PUMPE	PUMP POMPE
7. ELDNINGSAUTOMAT FEURUNGSAUTOMAT	OIL BURNER CONTROL COFFRET DU SECURITE
8. FLÄKTHUS BRENNERGEHÄUSE	FAN HOUSING CARTER DU ROTOR
9. LUFTREGLERING LUFTEINSTELLUNG	AIR REGULATION REGLAGE D'AIR
10. TRANSFORMATOR TRANSFORMATOR	TRANSFORMER TRANSFORMATEUR
11. SLANG ÖLSCHLAUCH	FLEXIBLE PIPE FLEXIBLE

	Brännarrör PL 80 mm 10-4-24-10 10-5-24-10 10-5-16-8 10-8-10-6-19-10 127 mm 10-8-10-6-19-10	Blast tube PL 80 mm 10-4-24-10 10-5-24-10 10-5-16-8 10-8-10-6-19-10 127 mm 10-8-10-6-19-10	Brennerrohr PL 80 mm 10-4-24-10 10-5-24-10 10-5-16-8 10-8-10-6-19-10 127 mm 10-8-10-6-19-10	Tube diffuseur PL 80 mm 10-4-24-10 10-5-24-10 10-5-16-8 10-8-10-6-19-10 127 mm 10-8-10-6-19-10	
					117 802 01
					117 803 01
					117 803 05
					117 804 01
					117 804 02
	Brännarrör PL 80 mm 6-7-21,5-10 6-7-19-10 127 mm 6-7-19-10 157 mm 6-7-19-8 6-7-16-8	Blast tube PL 80 mm 6-7-21,5-10 6-7-19-10 127 mm 6-7-19-10 157 mm 6-7-19-8 6-7-16-8	Brennerrohr PL 80 mm 6-7-21,5-10 6-7-19-10 127 mm 6-7-19-10 157 mm 6-7-19-8 6-7-16-8	Tube diffuseur PL 80 mm 6-7-21,5-10 6-7-19-10 127 mm 6-7-19-10 157 mm 6-7-19-8 6-7-16-8	
					117 801 03
					117 801 05
					117 801 06
					117 801 11
					117 801 09
	Brännarrör K, KA 94 mm 147 mm	Blast tube K, KA 94 mm 147mm	Brennerrohr K, KA 94 mm 147 mm	Tube diffuseur K, KA 94 mm 147 mm	
					117 284 01 117 284 02
	Brännarrör E 87 mm 124 mm	Blast tube E 87 mm 124 mm	Brennerrohr E 87 mm 124 mm	Tube diffuseur E 87 mm 124 mm	
					119 340 03 119 340 05
	Brännarrör FU 103 mm 133 mm	Blast tube FU 103 mm 133 mm	Brennerrohr FU 103 mm 133 mm	Tube diffuseur FU 103 mm 133 mm	
					117 643 01 117 643 04
	Brännarrör F, FV 127 mm	Blast tube F, FV 127 mm	Brennerrohr F, FV 127 mm	Tube diffuseur F, FV 127 mm	
					115 914 01
	Brännarrör C 94 mm	Blast tube C 94 mm	Brennerrohr C 94 mm	Tube diffuseur C 94 mm	
					117 385 14

97, 108, 120

BRÄNNARRÖR BRENNERROHR

BLAST TUBE TUBE DIFFUSEUR

1



Brännarrör
E
87 mm
215 mm
värmebeständigt

Blast tube
E
87 mm
215 mm
heat resistant

Brennerrohr
E
87 mm
215 mm
hitzbeständig

Tube diffuseur
E
87 mm
215 mm
résistant á la
chaleur







119 340 04







119 340 10

97, 108, 120

INSATS DÜSENSTOCK

NOZZLE ASSEMBLY LIGNE PORTE-GICLEUR 2

	Insats För brännarrör PL 80 mm 127 mm	Nozzle assembly For burner tube PL 80 mm 127 mm	Düsenstock Für Brennerrohr PL 80 mm 127 mm	Ligne porte-gicleur Pour tube diffuseur PL 80 mm 127 mm	118 616 01 118 616 02
	Insats För brännarrör E 87 mm 124 mm 212 mm	Nozzle assembly For burner tube E 87 mm 124 mm 212 mm	Düsenstock Für Brennerrohr E 87 mm 124 mm 212 mm	Ligne porte-gicleur Pour tube diffuseur E 87 mm 124 mm 212 mm	118 616 01 118 616 02 118 616 04
	Insats För brännarrör EM 87 mm	Nozzle assembly For burner tube EM 87 mm	Düsenstock Für Brennerrohr EM 87 mm	Ligne porte-gicleur Pour tube diffuseur EM 87 mm	118 616 01
	Insats För brännarrör KA, C 94 mm 147 mm	Nozzle assembly For burner tube KA, C 94 mm 147 mm	Düsenstock Für Brennerrohr KA, C 94 mm 147 mm	Ligne porte-gicleur Pour tube diffuseur KA, C 94 mm 147 mm	118 945 01 118 945 02
	Insats För brännarrör FUV 103 mm 133 mm	Nozzle assembly For burner tube FUV 103 mm 133 mm	Düsenstock Für Brennerrohr FUV 103 mm 133 mm	Ligne porte-gicleur Pour tube diffuseur FUV 103 mm 133 mm	118 943 01 118 943 02
	Insats För brännarrör PLV 127 mm ST97-108 127 mm Danfoss förvärmare ST 120	Nozzle assembly For burner tube PLV 127 mm ST97-108 127 mm Danfoss preheater ST 120	Düsenstock Für Brennerrohr PLV 127 mm ST97-108 127 mm Danfoss Vorwärmer ST 120	Ligne porte-gicleur Pour tube diffuseur PLV 127 mm ST97-108 127 mm Danfoss réchauffeur ST 120	118 944 02 118 946 02
	Insats För brännarrör FU 103 mm ST 108	Nozzle assembly For burner tube FU 103 mm ST 108	Düsenstock Für Brennerrohr FU 103 mm ST 108	Ligne porte-gicleur Pour tube diffuseur FU 103 mm ST 108	119 858 01

	Oljerör För brännarrör	Nozzle line For burner tube	Düsenrohr Für Brennerrohr	Canne porte-gicleur Pour tube diffuseur	
	FUV	FUV	FUV	FUV	
	103 mm	103 mm	103 mm	103 mm	119 190 01
	133 mm	133 mm	133 mm	133 mm	119 190 07
	Oljerör För brännarrör	Nozzle line For burner tube	Düsenrohr Für Brennerrohr	Canne porte-gicleur Pour tube diffuseur	
	PLV	PLV	PLV	PLV	
	127 mm	127 mm	127 mm	127 mm	119 190 01
	ST 97-108	ST 97-108	ST 97-108	ST 97-108	
	127 mm	127 mm	127 mm	127 mm	119 190 03
	ST 120	ST 120	ST 120	ST 120	
	Oljerör För brännarrör	Nozzle line For burner tube	Düsenrohr Für Brennerrohr	Canne porte-gicleur Pour tube diffuseur	
	PL	PL	PL	PL	
	80 mm	80 mm	80 mm	80 mm	119 189 01
	127 mm	127 mm	127 mm	127 mm	119 189 02
	Oljerör För brännarrör	Nozzle line For burner tube	Düsenrohr Für Brennerrohr	Canne porte-gicleur Pour tube diffuseur	
	E	E	E	E	
	87 mm	87 mm	87 mm	87 mm	119 189 01
	124 mm	124 mm	124 mm	124 mm	119 189 02
	212 mm	212 mm	212 mm	212 mm	119 189 04
	Oljerör För brännarrör	Nozzle line For burner tube	Düsenrohr Für Brennerrohr	Canne porte-gicleur Pour tube diffuseur	
	EM	EM	EM	EM	
	87 mm	87 mm	87 mm	87 mm	119 189 01
	Oljerör För brännarrör	Nozzle line For burner tube	Düsenrohr Für Brennerrohr	Canne porte-gicleur Pour tube diffuseur	
	K, KA, C	K, KA, C	K, KA, C	K, KA, C	
	94 mm	94 mm	94 mm	94 mm	119 189 07
	147 mm	147 mm	147 mm	147 mm	119 189 05
	Oljerör För brännarrör	Nozzle line For burner tube	Düsenrohr Für Brennerrohr	Canne porte-gicleur Pour tube diffuseur	
	KAV	KAV	KAV	KAV	
	147 mm	147 mm	147 mm	147 mm	119 190 08

	Fövärmare Danfoss	Preheater Satronic Danfoss	Vorwärmer Danfoss	Réchauffeur Danfoss	114 706 05
	Kabel. fövärmare	Cable, preheater	Kabel, Vorwärmer	Cable,réchauffeur	114 777 02
	Elektrodhållare	Elektrode holder	Elektrodenhalter	Porte-électrode	115 984 01
	Skala, insatsreglering	Scale, nozzle assembly adjustment	Skala, Düsenstock- einstellung	Echelle, ligne porte-gicleur	118 881 01
	Täckplåt, insatsreglering	Coverplate, nozzle assembly adjustment	Deckplatte, Düsenstock- einstellung	Plaque de recouvrement, ligne porte-gicleur	118 530 02
	Täckplåt, insatsreglering	Coverplate, nozzle assembly adjustment	Deckplatte, Düsenstock- einstellung	Plaque de recouvrement, ligne porte-gicleur	118 873 01
	Ställskruv, insats	Adjustment screw, nozzle assembly	Stellschraube, Düsenstock	Vis de réglage, ligne porte-gicleur	118 484 01
	Bussning	Bushing	Buchse	Douille	118 479 01
	Distansrör	Spacing tube	Abstandsrohr	Tube d'écartement	117 416 01
	Bromsskiva FUV	Brake plate FUV	Stauscheibe FUV	Disque accroche- flamme FUV	115 912 02

	Bromsskiva	Brake plate	Stauscheibe	Disque accroche-flamme	115 915 01
	Tändelektrod, par	Ignition electrode, pair of	Zündelektrode, paar	Electrode d'allumage, 1 paire	115 937 01 915 937 01
	O-ring, förvärmare	O-ring, preheater	O-ring, Vorwärmer	Joint torique, réchauffeur	113 168 02
	Låsring, förvärmare	Locking ring, preheater	Sicherungsring, Vorwärmer	Circlip, réchauffeur	118 018 02
	Bromsskiva KA, KAV	Brake plate KA, KAV	Stauscheibe KA, KAV	Disque accroche- flamme KA, KAV	118 858 01
	Insats förbrännarrör FV 127 mm	Nozzle assembly For burner tube FV 127 mm	Düsenstock fürbrennerrohr FV 127 mm	Ligne porte-gicleur Pour tube diffuseur FV 127 mm	118 943 01
	Insats förbrännarrör KAV 147 mm	Nozzle assembly For burner tube KAV 147 mm	Düsenstock fürbrennerrohr KAV 147 mm	Ligne porte-gicleur Pour tube diffuseur KAV 147 mm	119 075 05
	Dubbelektrod	Double electrode	Doppelelektrode	Electrode double	118 867 01
	Oljerör Förbrännarrör FU 103 mm ST108	Nozzle-line For burner tube FU 103 mm ST108	Düsenrohr Für Bremmemrohr FU 103 mm ST108	Canne porte-gicleur Pour tube diffuseur FU 103 mm	119 189 02

	Anslutningsfläns	Fixing flange	Anschlussflansch	Bride de fixation	118 525 01
	Anslutningsfläns	Fixing flange	Anschlussflansch	Bride de fixation	118 116 01
	Anslutningsfläns	Fixing flange	Anschlussflansch	Bride de fixation	04 390 308 34
	Packning	Gasket	Dichtung	Joint	118 542 01
	Packning	Gasket	Dichtung	Joint	118 191 01
	Packning	Gasket	Dichtung	Joint	04 390 120 27
	Packning	Gasket	Dichtung	Joint	118 543 01
	Anslutningsfläns	Fixing flange	Anschlussflansch	Bride de fixation	118 830 01
	Packning	Gasket	Dichtung	Joint	118 831 01
	Packning	Gasket	Dichtung	Joint	118 756 03

97, 108, 120

**ANSLUTNINGSFLÄNS
ANSCHLUSSFLANSCH**

**FIXING FLANGE
BRIDE DE FIXATION**

3

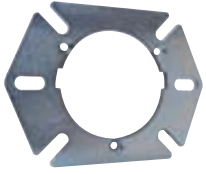

Anslutningsfläns

Fixing flange

Anschlussflansch

Bride de fixation

118 545 01

97, 108, 120

KÅPA
HAUBE

COVER
CAPOT

4



Täcklock

Coverplate

Deckplatte

Plaque
de recouvrement

118 500 01



Skruv

Screw

Schraube

Vis

117 507 02

	Motor 90W, 4µF 4µF Svart 3µF	Motor 90W 4µF 4µF Black 3µF	Motor 90W 4µF 4µF Schwarz 3µF	Moteur 90W 4µF 4µF Noir 3µF	918 483 02 918 483 03 918 483 04
	Fläkthjul 120 x 42 x 8 ST 120	Fan wheel 120 x 42 x 8 ST 120	Gebläserad 120 x 42 x 8 ST 120	Rotor 120 x 42 x 8 ST 120	114 176 01
	97 x 42 x 8 ST 97	97 x 42 x 8 ST 97	97 x 42 x 8 ST 97	97 x 42 x 8 ST 97	114 176 03
	108 x 42 x 8 ST 108	108 x 42 x 8 ST 108	108 x 42 x 8 ST 108	108 x 42 x 8 ST 108	114 176 04
	Drivkoppling	Drive coupling	Antriebskuppling	Accouplement d'entraînement	114 072 10
	O-ring 121,0 x 1,6	O-ring 121,0 x 1,6	O-Ring 121,0 x 1,6	Joint torique 121,0 x 1,6	113 168 41
	Kondensator 3µF 4µF	Capacitor 3µF 4µF	Kondensator 3µF 4µF	Condensateur 3µF 4µF	115 965 04 115 965 01
	Kabel	Cable	Kabel	Câble	117 034 04

	Pump BFP11L3 Styckförpackning Med kabel	Pump BFP11L3 Single-piece package With cable	Pumpe BFP11L3 Stückverpackung Mit Kabel	Pompe BFP11L3 Emballage par pièces Avec câble	119 758 02 819 758 02 919 758 02
	Pump AS47C-4P ersatt av AS47C-6P Pump AS47C-5M ersatt av AS47C-6M	Pump AS47C-4P replaced by AS47C-6P Pump AS47C-5M replaced by AS47C-6M	Pumpe AS47C-4P ersetzt durch AS47C-6P Pumpe AS47C-5M ersetzt durch AS47C-6M	Pompe AS47C-4P remplacée par AS47C-6P Pompe AS47C-5M remplacée par AS47C-6M	
	Förbindelserör ST 120	Connecting pipe ST 120	Öldruckrohr ST 120	Trompette ST 120	118 551 01 118 638 01 118 845 01
	Förbindelserör PL 80 mm PL 127, 157 mm FU103mm ST 97/108,	Connecting pipe PL 80 mm PL 127, 157 mm FU103mm ST 97/108,	Öldruckrohr PL 80 mm PL 127, 157 mm FU103mm ST 97/108,	Trompette PL 80 mm PL 127, 157 mm FU103mm ST 97/108,	118 607 01 118 695 02 115 976 05 118 819 01
	Nippel, manometer	Nipple, pressure gauge	Nippel, Manometer	Raccord, manomètre	118 819 02
	Förbindelserör FUV, PLV 127mm	Connecting pipe FUV, PLV 127 mm	Öldruckrohr FUV, PLV 127 mm	Trompette FUV, PLV 127mm	
	Kabel 400 mm BFP 11L3 AS47C	Cable 400 mm BFP 11L3 AS47C	Kabel 400 mm BFP 11L3 AS47C	Câble 400 mm BFP 11L3 AS47C	
	Förbindelserör E 215 mm K 147 mm ST 120	Connecting pipe E 215 mm K 147 mm ST 120	Öldruckrohr E 215 mm K 147 mm ST 120	Trompette E 215 mm K 147 mm ST 120	
	Magnetventil BFP Innerdel	Solenoid valve BFP Inner part	Magnetventil BFP Einsatz	Electrovanne BFP Partie interieure	
	Magnetventil AS47C	Solenoid valve AS47C	Magnetventil AS47C	Electrovanne AS47C	

	Spole Suntec Danfoss BFP	Coil Suntec Danfoss BFP	Spule Suntec Danfoss BFP	Bobine Suntec Danfoss BFP	915 971 01 115 974 03
	Pump BFP41L3 Styckförpackning	Pump BFP41L3 Single-piece package	Pumpe BFP41L3 Stückverpackung	Pompe BFPL3 Emballage par pièces	119 758 01 819 758 01
	Med kabel	With cable	Mit Kabel	avec câble	919 758 01
	Filter BFP41L3	Filter BFP41L3	Filter BFP41L3	Filtre BFP41L3	117 749 01
	Filter AS47C	Filter AS47C	Filter AS47C	Filtre AS47C	114 570 02
	Packning, lock Suntec AS47C-4P AS47C-5M	Gasket, cover Suntec AS47C-4P AS47C-5M	Dichtung, Deckel Suntec AS47C-4P AS47C-5M	Joint, couvercle Suntec AS47C-4P AS47C-5M	114 566 01
	Packning, lock Danfoss	Gasket, cover Danfoss	Dichtung, Deckel Danfoss	Joint, couvercle Danfoss	119 810 01
	Pump AS47C-6P Styckförpackning	Pump AS47C-6P Single-piece package	Pumpe AS47C-6P Stückverpackung	Pompe AS47C-6P Emballage par pièces	120 264 32 820 264 32
	Med kabel 2-rörs	With cable 2-pipe	Mit Kabel 2-Rohr	Avec câble 2 tuyaux	920 264 32
	Pump AS47C-6M Styckförpackning	Pump AS47C-6M Single-piece package	Pumpe AS47C-6M Stückverpackung	Pompe AS47C-6M Emballage par pièces	120 264 31 820 264 31
	Med kabel 1-rörs	With cable 1-pipe	Mit Kabel 1-Rohr	Avec câble 1 tuyau	920 264 31
	Packning, lock Suntec AS47C-6P AS47C-6M	Gasket, cover Suntec AS47C-6P AS47C-6M	Dichtung, Deckel Suntec AS47C-6P AS47C-6M	Joint, couvercle Suntec AS47C-6P AS47C-6M	114 566 02

	Reläbox TF 832.3 Industriförpackning Styckförpackning	Control box TF 832.3 Industrial package Single-piece package	Steuergerät Oberteil TF 832.3 Industrie verpackung Stückverpackung TF 834E.3	Boite de contrôle TF 832.3 Emballage industriel Emballage par pièces	117 810 07 917 810 07
	TF 834E.3 Industriförpackning Styckförpackning	TF 834E.3 Industrial package Single-piece package	Industrie verpackung Stückverpackung	TF 834E.3 Emballage industriel Emballage par pièces	117 027 04 917 027 04
	Reläbox LOA 24 Industriförpackning Styckförpackning	Control box LOA 24 Industrial package Single-piece package	Steuergerät Oberteil LOA 24 Industrie verpackung Stückverpackung	Boite de contrôle LOA 24 Emballage industriel Emballage par pièces	115 595 04 915 595 04
	Reläsockel Satronic kpl. för kallstart	Relay base Satronic compl. for cold start	Steuergerät Unterteil Satronic kompl. für Kaltstart	Socle de raccordement Satronic pour démarrage à froid	118 012 04
	Reläsockel Landis & Staefa kpl.	Relay base Landis & Staefa compl.	Steuergerät Unterteil Landis & Staefa kompl.	Socle de raccordement Landis & Staefa compl.	915 596 00
	Reläsockel Satronic kpl.	Relay base Satronic compl.	Steuergerät Unterteil Satronic kompl.	Socle de raccordement Satronic compl.	90 390 109 01
	Fläns, fotomotstånd Satronic	Flange, photoresistor Satronic	Flansch, Fotowiderstand Satronic	Bride, cellule photorésistante Satronic	390 113 03
	Fläns, fotomotstånd Landis & Staefa	Flange, photoresistor Landis & Staefa	Flansch, Fotowiderstand Landis & Staefa	Bride, cellule photorésistante Landis & Staefa	117 768 01
	Fotomotstånd Satronic MZ 770S långt utförande kort utförande	Photoresistor Satronic MZ 770S long design short design	Fotowiderstand Satronic MZ 770S lange Ausführung kurze Ausführung	Cellule photorésistante Satronic MZ 770S longue courte	118 003 01 118 003 03

	Packning, fotomotstånd	Gasket, photoresistor	Dichtung, Fotowiderstand	Joint, cellule photorésistante	118 560 01
	Kontaktдон, hondel 7-pol	Plug-in contact, female 7-pole	Buchsenteil 7-polig	Prise "européenne", femelle 7-polaire	115 586 04
	Kontaktдон, handel 7-pol	Plug-in contact, male 7-pole	Steckerteil 7-polig	Prise "européenne", mâle 7-polaire	115 585 00
	Kabelgenomföring	Cable inlet	Kabeldurchführung	Douille de passage câble	118 100 01
	Kabel MZ770	Cable MZ770	Kabel MZ770	Câble MZ770	118 561 01
	Fotomotstånd Landis & Staefa QRB1-A kpl.	Photoresistor Landis & Staefa QRB1-A compl.	Fotowiderstand Landis & Staefa QRB1-A compl.	Cellule photorésistante, Landis & Staefa QRB1-A compl.	912 409 05 912 409 07
	kort utförande långt utförande	short design long design	kurze Ausführung lange Ausführung	courte longue	
	Fotomotstånd Satronic MZ770	Photoresistor Satronic MZ 770	Fotowiderstand Satronic MZ 770	Cellule photorésistante Satronic MZ 770	04 390 295 67

	Fläkthusdel, bakre röd omålad	Fan housing, rear part red non-lacquered	Brennergehäuse, hinterer Teil rot nicht lackiert	Carter du rotor, partie arrière rouge non-lacqué	118 497 0227 118 497 02
	Fläkthusdel, främre röd omålad KA ST 120	Fan housing, front part red non-lacquered KA ST 120	Brennergehäuse, vorderer Teil rot nicht lackiert KA ST 120	Carter du rotor, partie frontale rouge non-lacqué KA ST 120	118 495 0227 118 495 02 118 884 0227
	Fläkthusdel, främre röd omålad ST 97/108	Fan housing, front part red non-lacquered ST 97/108	Brennergehäuse, vorderer Teil rot nicht lackiert ST 97/108	Carter du rotor, partie frontale rouge non-lacqué ST 97/108	118 569 0227 118 569 02
	Avskärningsvägg, fläkthus ST 120 ST 97/108	Shielding arrangement, fan housing ST 120 ST 97/108	Abschirmung, Brennergehäuse ST 120 ST 97/108	Ecran de partition, carter du rotor ST 120 ST 97/108	118 496 01 118 608 01
	Packning, fläkthus	Gasket, fan housing	Dichtung, Brennergehäuse	Joint, carter du rotor	118 544 01

	Bussning	Bushing	Buchse	Douille	118 479 01
	Anslutningsstos kpl.	Connecting piece compl.	Anschluss-Stück kompl.	Pièce de raccordement compl.	918 591 04
	Packing, anslutningsstos	Gasket, connecting piece	Dichtung, Anschluss-Stück	Joint, Pièce de raccordement	118 541 01
	Luftregleringsplåt	Air regulation plate	Lufteinstellplatte	Plaque de réglage d'air	118 522 01
	Luftspjäll	Air damper	Luftklappe	Volet d'air	118 510 01
	Ställskruv, luftreglering	Adjustment screw, air regulation	Stellschraube, Lufteinstellung	Vis de réglage, réglage d'air	118 485 01
	Skala, luftreglering	Scale air regulation	Skala, Lufteinstellung	Echelle, réglage d'air	118 878 01
	Täckplåt, luftreglering	Cover plate, air regulation	Deckplatte, Lufteinstellung	Plaque de recouvrement, réglage d'air	118 870 01
	Ljuddämpare, svart Med ram för självstängande luftspjäll, omålad svart	Silencer, black With frame for automatic air damper, non-lacquered black	Schalldämpfer, schwarz Mit Rahmen für Luftansaug- vorrichtung, nicht lackiert schwarz	Silencieux, noir Avec cadre pour clapet d'air automatique, non-lacqué noir	118 749 0105 918 838 01 918 838 02









Anslutningstos
kompl.
svart

Connection piece
compl.
black

Anschluss-Stück
kompl.
schwarz

Piece de
raccordement
compl.
noir

918 591 07

	Transformator Danfoss EBI kpl. Industriförpackning	Transformer Danfoss EBI compl. Industrial package	Transformator Danfoss EBI kompl. Industrie verpackung	Transformateur Danfoss EBI compl. Emballage industriell	915 977 01 115 977 01
	Kabelgenomföring	Cable inlet	Kabeldurch- führung	Douille de Câble H.T.	118 546 01
	Fästfjäder, transformator	Fixing spring, transformer	Befestigungs- feder, Transformator	Ressort de fixation, transformateur	118 558 01
	Tändkabelpar	Pair of ignition cable	Zündkabelpaar	Câble H.T. 1 paire	120 219 01
	Kabel med clips transformator	Cable with clips transformer	Kabel mit Klammern, Transformator	Câble avec crampons, transformateur	117 570 12
	Kabel transformator	Cable, transformer	Kabel Transformator	Câble transformateur	117 570 02



Oljeslang,
vinkel

Flexible pipe with
angle nipple

Ölschlauch mit
Winkelniessel

Flexible avec
raccord coudé

1/4"x500x1/4"

1/4"x500x1/4"

1/4"x500x1/4"

1/4"x500x1/4"

117 808 01

1/4"x1000x1/4"

1/4"x1000x1/4"

1/4"x1000x1/4"

1/4"x1000x1/4"

115 545 13

1/4"x700x1/4"

1/4"x700x1/4"

1/4"x700x1/4"

1/4"x700x1/4"

117 808 02

1/4"x700x1/4"

1/4"x700x1/4"

1/4"x700x1/4"

1/4"x700x1/4"

117 807 02